

# SG-EQ4

## 4 LOAD CELLS JUNCTION BOX

### User Manual

#### Contents:

- General Information
- 4-wire / 6-wire load cells
- Electrical connections
- 4-wire load cells trimming
- Internal Jumpers

SENECA s.r.l.  
Via Germania, 34 - 35127 - Z.I. CAMIN - PADOVA - ITALY  
Tel. +39.049.8705355 - 8705359 - Fax +39.049.8706287  
e-mail: info@seneca.it - www.seneca.it

This document is property of SENECA srl. Duplication and reproduction are forbidden, if not authorized. Contents of the present documentation refers to products and technologies described in the document may be modified without prior notice. Content of this documentation is subject to periodical revision.

#### 4-Wire Load Cells Connections

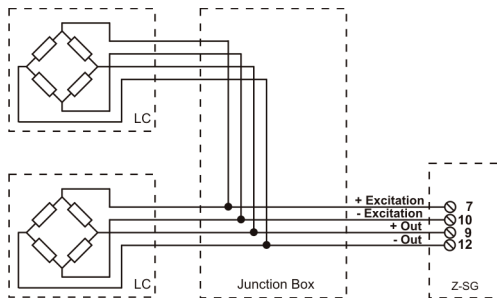

#### 6-Wire Load Cells Connections

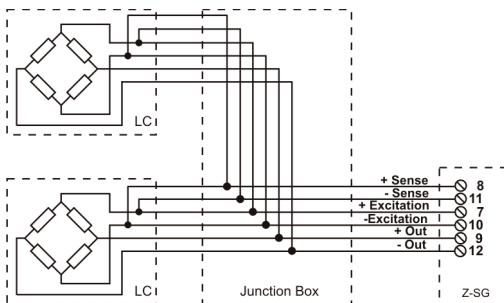

#### Grounding and Shielding

Proper grounding and shielding can be critical to the successful application of load cells which are generating low level signals (< 5  $\mu$ V / scale division). The basic rule is:

*Avoid continuous ground loops; a system should not be grounded at multiple points. This may occur, for example, if the shield of the load cell cable is connected to earth at both ends.*

The great part of load cell cables are provided with a braided shield which provides protection from electrostatic interference when properly used. This shield is floating (not connected) at the load cell avoiding the inadvertent creation of a "ground loop". A basic system configuration is represented in the figure below:

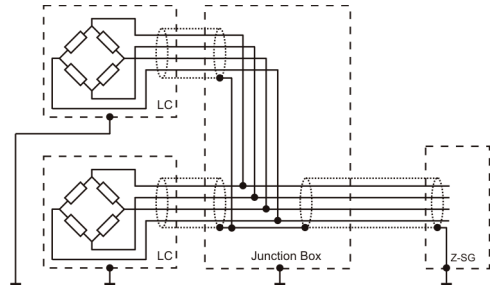

The load cell case and junction box are grounded by mechanical attachment to the structure to which they are mounted. Usually this structure is grounded. The braided shield enclosing the load cell leads is grounded at the signal conditioning device/converter (Z-SG for example), which is grounded through the power cord or housing.

In order to avoid interference, load cells cables and extension cables should be kept away from power circuits, with a recommended distance of at least one meter. Power supply cables should be crossed at right angles.

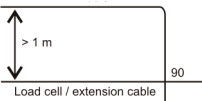

#### 4-WIRE LOAD CELLS TRIMMING

The figure below shows a diagram of three excitation trimmed load cells. A temperature-independent variable resistor or potentiometer of typically 20  $\Omega$  is inserted in the + excitation lead of each load cell.

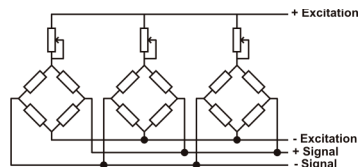

There are two methods of trimming with excitation. The first method is to adjust the potentiometers by trial and error while moving calibration weights around from corner to corner. All potentiometers should be adjusted to have the maximum sensitivity for each cell by completely turning all of them clockwise.

Then once the lowest output corner is located, the other cells are trimmed down to match this lowest output.

This method may be very time consuming, particularly for high capacity scales, or vessel scales where the use of test weights at the corners is not practical. In these cases the second and best method is "pre-trimming" the potentiometers with the use of a sensitive voltmeter (at least 4-1/2 digit). The following procedure can be used:

- 1) Determine the exact mV/V rating of each load cell, which can be found on the load cell's calibration certificate.
- 2) Determine the exact excitation voltage supplied by the signal conditioning device/converter (Z-SG for example) by measuring this voltage with the voltmeter (for example 10.05 V)
- 3) Multiply the lowest mV/V-value (step 1) by the excitation voltage (step 2).
- 4) Divide the trimming-factor found in step 3 by the mV/V-value for the remaining load cells.
- 5) Measure and adjust the excitation voltage of the three remaining load cells with each respective potentiometer. Verify the results and make the final adjustment while moving a test load from corner to corner.

4-wire Load Cells	
SETTING	JUMPER POSITIONS
Trimmer ON	J1 / J2 / J3 / J4 in position 1
Trimmer OFF	J1 / J2 / J3 / J4 in position 3
6-wire Output	JA / JB in position 1
4-wire Output	JA / JB in position 3

6-wire Load Cells	
SETTING	JUMPER POSITIONS
Trimmer OFF	J1 / J2 / J3 / J4 in position 3
6-wire Output	JA / JB in position 1
4-wire Output	JA / JB in position 3

The internal jumpers **Position 1** and **3** are illustrated on the following figure. On the board the positions are pointed out by the corresponding number at the sides of the jumpers.

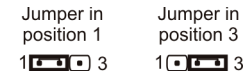

Disposal of Electrical & Electronic Equipment (Applicable throughout the European Union and other European countries with separate collection programs). This symbol, found on your product or on its packaging, indicates that this product should not be treated as household waste when you wish to dispose of it. Instead, it should be handed over to an applicable collection point for the recycling of electrical and electronic equipment. By ensuring this product is disposed of correctly, you will help prevent potential negative consequences to the environment and human health, which could otherwise be caused by inappropriate disposal of this product. The recycling of materials will help to conserve natural resources. For more detailed information about the recycling of this product, please contact your local city office, waste disposal service or the retail store where you purchased this product.

#### GENERAL INFORMATION

Most industrial load cells are used in multiple load cell weighing systems. Load cells should be electrically connected in such a way that the signal (output) lines, excitation (power supply) and sense (when present) lines are in parallel. Usually the connection is not made at the signal conditioning device, but in a separate housing, a so called junction box, located adjacent to the weighing system.

#### 4-WIRE / 6-WIRE LOAD CELLS

A load cell may have a cable with four or six wires. A six-wire cable, besides having +/- excitation and +/- signal lines also has + and - sense lines. It is a common misconception that the possibility to sense the actual voltage at the load cell is the only difference between 4-wire and 6-wire load cells.

A load cell is compensated to perform within specifications over a certain temperature range (usually -10 - + 40 °C). Since cable resistance is a function of temperature, the cable response to temperature-changes must be eliminated. The 4-wire cable is part of the temperature compensating system of the load cell. The load cell is calibrated and compensated with a certain amount of cable attached. **Never cut a 4-wire load cell cable.**

The 6-wire cable is not part of the temperature compensating system of the load cell. The sense lines are connected to the sense terminals of the signal conditioning device, to feed back the actual voltage at the load cells. The signal conditioning device either adjusts its output voltage or adjusts its amplifier to compensate for any resistance change in the cable. The advantage of using this "active" system is the possibility to cut (or extend) the 6-wire load cell cable to any length. **A 6-wire load cell will not perform within specifications if the sense lines are not used.**

#### ELECTRICAL CONNECTIONS

The following figures represent the two basic configurations, using four- or six-wire (sense) load cells and Z-SG as signal conditioning device (converter). With 4-wire extension cables the load cell output should be connected to pairs of diagonally opposite wire.

Sometimes it is necessary to trim the output of each individual load cell to avoid corner load differences, which are caused by:

- 1) The parallel connection. Each load cell will be loaded with the resistance of the other load cells. As a result, the individual load cell output tolerances will be increased by the individual output resistance tolerance.
- 2) Unequal load distribution.

**All Load cells should be placed at the same horizontal level. Check for mechanical unequal load conditions before trimming the load cells.**

#### Internal Jumpers

Internal jumpers are available on the internal board inside the case. Their position in the board is illustrated in the following figures:

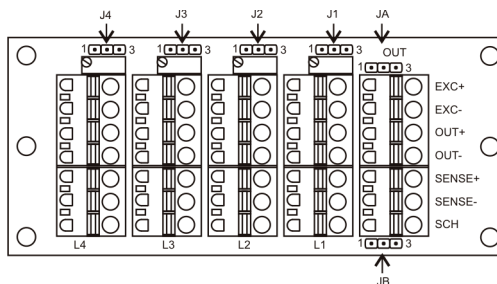

The jumpers may be set in order to establish particular settings as illustrated in the tables on the next page: