

Input: 0-50 mV to ±10 VDC, 0-500 µA to 4-20 mA DC, Potentiometer, T/C, RTD, Thermistor, or Custom
Output: 0-1 V to 0-10 V, ±5 V, ±10 V, 0-2 mA to 4-20 mA

Quick Link: api-usa.com/8000

- One Model Covers All Common Sensors
- Easy Setup—No Computer or Software Needed
- Zero and Span Output Calibration Buttons
- Full 1200 V Isolation
- Input LoopTracker® LED, Output Test Function
- Built-In Loop Power Supply for Sink/Source Output



Applications Link
api-usa.com/apps

Free Factory I/O Setup!



Applications

- Convert/Isolate DC Sensors for PLC Input, Control and/or Validation
- Interface DC Sensors with Panel Meters, PLCs, Recorders, Data Acq., DCS, & SCADA Systems

Input Types, Field Selectable

DC volts: 35 ranges from ±25 mVDC to ±10 VDC
 DC mA: 20 ranges from ±0.5 mA DC to ±20 mA DC
 Potentiometer: 100 Ω min. to 1 Mega Ω max.
 1, 2, or 4 volt excitation
 T/Cs: J, K, T, E, R, S, N, B, C, D, G, M, P
 Full ANSI temperature ranges, Automatic CJC
 T/C current: Less than 10 µA, including burnout sense
 Upscale (standard), downscale, or none
 T/C burnout:
 RTDs: 2, 3, or 4 wire, 10 Ω to 8000 Ω RTDs
 4 wire with or without current rotation
 Cu-10, Cu-100, Ni-100, Ni-120,
 Ni-Fe-500, Ni-Fe-1000, Ni-Fe-2000,
 Pt-10, Pt-25, Pt-50, Pt-100, Pt-200,
 Pt-470, Pt-500, Pt-1000
 Thermistors: 44004/44033 2.252 kΩ at 25°C
 44005/44030 3.000 kΩ at 25°C
 44007/44034 5.000 kΩ at 25°C
 44006/44031 10.00 kΩ at 25°C
 44008/44032 30.00 kΩ at 25°C
 YSI 400 2.252 kΩ at 25°C
 Spectrum 1003k 1 kΩ
 Custom: Provide sensor specifications, temperature curve data, and temperature range

Temperature Input Specifications

Measurement accuracy: ±0.1°C and 0.001°C resolution
 Linearization: 41-55 segment or up to 14th order polynomial

Input Impedance

Voltage: 25 kΩ minimum, Current: 50 Ω nominal

LoopTracker

Variable brightness green LED indicates input level and status

Status LED

Yellow LED for setup and operational status

DC Output Ranges, Field Selectable

Voltage: 0-1 V, 0-2 V, 0-4 V, 0-5 V, 1-5 V, 0-8 V, 0-10 V,
 2-10 V, ±5 VDC, ±10 VDC
 Current: 0-2 mA, 0-4 mA, 0-8 mA, 0-10 mA, 2-10 mA,
 0-16 mA, 0-20 mA, 4-20 mA
 20 V compliance, 1000 Ω at 20 mA

Reverse Acting Output, Factory Set

R option: Reverse acting output
 Reverse acting models cannot be converted to direct acting

Output Calibration

Zero and span set by using up/down buttons, ±10% range

Output Loop Power Supply

20 VDC nom., regulated, 25 mA DC, <10 mVrms max. ripple
 May be selectively wired for sinking or sourcing mA output

Output Test

Front push button switch enables/disables test level output
 Adjustable 0-100% of span via up/down buttons

Output Resolution

18 bit

Output Ripple and Noise

Less than ±0.2% of span

Ambient Temperature Range and Stability

-10°C to +60°C operating ambient
 Better than ±0.02% of span per °C stability

Response Time

300 milliseconds nominal

Isolation

Full 3-way isolation: input, output, power, 1200 VRms min.
 600 VACp or 600 VDC common mode protection
 75 dB minimum common mode rejection
 Simultaneous 50 Hz and 60 Hz rejection

Housing and Connectors

IP 40, requires vertical installation on a 35 mm DIN rail inside a panel or enclosure
 For use in Pollution Degree 2 Environment
 Four 4-terminal removable connectors, 14 AWG max. wire size

Power

85-265 VAC, 50/60 Hz or 60-300 VDC, 3 W maximum
 D versions: 9-30 VDC or 10-32 VAC 50/60 Hz, 3 W maximum

Dimensions (with connectors)

0.89" W x 4.62" H x 4.81" D (22.5 x 117 x 122 mm)

Description

The APD 8000 accepts a DC, potentiometer, thermocouple, RTD or thermistor input and provides an optically isolated and linearized DC voltage or current output. The input is sampled, digitally converted (and linearized for temperature sensors), and then passed through an optocoupler to the output stage.

Full 3 way isolation (input, output, power) make this module useful for ground loop elimination, common mode signal rejection, and noise pickup reduction.

The input type and range, and output type and range are field configurable. This provides a versatile solution that works with all commonly available sensors.

Microprocessor-based linearization uses 41 to 55 segments or up to a 14th order polynomial depending on the sensor type.

The input type is set with switches and its range is configured using front buttons, a multimeter and an input simulator.

The low noise 18 bit analog output is isolated and can be set up for common voltage and milliamp output types.

How to Order

Default settings are type J T/C, 0-500°C, 4-20 mA output. Provide I/O settings for factory setup. Field calibration may still be required. Specify the following.

- DC: Range and mV, volts, or mA
- Temperature: Range in °F or °C (for temperature input)
- T/C: Thermocouple type, burnout setting
- RTD: Model/type, resistance, curve, number of wires
 If 4 wire: with or without current rotation
- Thermistor: Sensor model/type, resistance
- Custom: Complete sensor data over temperature range
- Output: Range and type (mV, V, mA)

Sink or Source mA Output 1 2 3 4

Removable Plugs 5 6 7 8

Setup and Status LED

Input LoopTracker LED

Adjustable Output Test Function

Output Zero and Span

Universal Input

9 10 11 12

13 14 15 16

Universal Power



See Wiring Diagrams on Next Page

Output Sink/Source Versatility

Standard on the APD 8000 is a 20 VDC loop excitation supply for the milliamp output. The output can be selectively wired for sinking or sourcing allowing use with a powered or unpowered milliamp device.

LoopTracker

An API exclusive feature includes a green LoopTracker LED that varies in intensity with changes in the process input signal.

It provides a quick visual picture of your process input at all times and can greatly aid in saving time during initial startup and troubleshooting.

Output Test

An API exclusive feature includes an output test switch to provide a fixed output (independent of the input) when pressed. The output test greatly aids in saving time during initial startup and/or troubleshooting.

The test output level is adjustable from 0 to 100% of the output span.

Model	Description	Power
APD 8000	Universal input to DC output	85-265 VAC, 50/60 Hz or 60-300 VDC
APD 8000 D	isolated transmitter	9-30 VDC or 10-32 VAC

Options and Accessory

Options—add to end of model number

- U Conformal coating for moisture resistance
- R Reverse acting output

Accessory—order as separate line item

API BP4 Spare removable 4 terminal plug, black

Precautions

WARNING! All wiring must be performed by a qualified electrician or instrumentation engineer. See diagram for terminal designations and wiring examples. Consult factory for assistance.

WARNING! Avoid shock hazards! Turn signal input, output, and power off before connecting or disconnecting wiring, or removing or installing module.

Précautions

ATTENTION! Tout le câblage doit être effectué par un électricien ou ingénieur en instrumentation qualifié. Voir le diagramme pour désignations des bornes et des exemples de câblage. Consulter l'usine pour assistance.

ATTENTION! Éviter les risques de choc! Fermez le signal d'entrée, le signal de sortie et l'alimentation électrique avant de connecter ou de déconnecter le câblage, ou de retirer ou d'installer le module.

API maintains a constant effort to upgrade and improve its products. Specifications are subject to change without notice. See api-usa.com for latest product information. Consult factory for your specific requirements.

Range Selection

Select ranges before installation. A thermistor input or a 4 wire RTD with current rotation input requires changing an internal jumper. Use the table on the next pages to select the I/O ranges and jumper settings. The module side label lists output ranges.

Check the model/serial number label for module power, options, or custom range information. A custom range uses switch settings described in the Custom Range Table.

Models with **R** reverse acting output use the same switch settings, except the output range is reversed (4-20 mA is 20-4 mA).

1. Set switches A, B, and C from the table to set input type and range.
2. Set switches D and E from the table to set the output range and set switch E: V for voltage or I for current output.

For output ranges that fall between the listed ranges use the next highest setting. The output can be trimmed using the Output Level Adjustment procedure.

Electrical Connections

See wiring diagrams at right. A multimeter and a signal or temperature simulator are required for setup. Observe polarity. If the output does not function, check wiring and polarity.

* Do not make any connections to unused terminals or use them as wiring junctions for external devices. This may cause permanent damage to the module!

The power supplies are fuse protected and the unit may be returned to API for fuse replacement.

Input

The sensor input is connected as shown in the wiring diagrams at right. If a custom input was specified, see the model/serial number label for sensor type, range, or options. Your device must provide loop power for a milliamp input.

Output

For milliamp ranges, determine if your device provides power to the current loop or if the loop must be powered by the APD module. Typical voltage may be 9-24 VDC at your device's terminals if it provides power to the loop.

Module Power

Check model/serial number label for module operating voltage to make sure it matches available power.

When using DC power, either polarity is acceptable, but for consistency with similar API products, positive (+) can be wired to terminal 13 and negative (-) can be wired to terminal 16.

DC Voltage Output

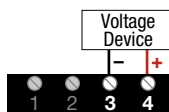

DC mA Sourcing Output

The APD 8000 will be the source of 20 Volt power for the mA output loop.

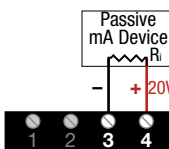

mADC Sinking Output and Powered mA Device

Your device will be the source of power for the mA output loop.

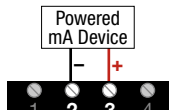

mADC Sinking Output with External Loop Supply

This example uses a passive mA device with an external loop supply to power the mA output loop.

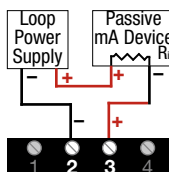

DC Signal Input

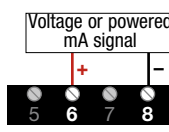

Potentiometer Input

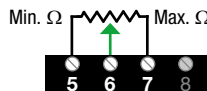

Yellow status LED

Setup: blinks once per second
Off: normal operation
Flashing 2 digit code: error

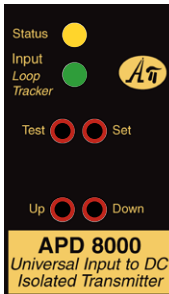

Green LoopTracker LED

Brightness varies with input level

Thermocouple Input

Thermocouple wire colors vary by type and country.
USA ANSI: Red is negative
IEC: White is negative

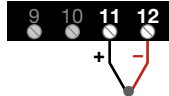

Thermistor Input

Thermistor input requires changing the internal jumper



2 Wire RTD Input

Wire colors may vary

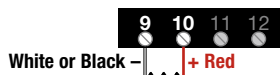

3 Wire RTD Input

Wire colors may vary



4 Wire RTD Input

RTD input with current rotation requires changing an internal jumper. Wire colors may vary.

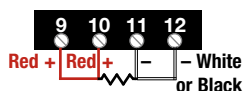

Module Power

APD 8000: 85-265 VAC, 50/60 Hz or 60-300 VDC

APD 8000 D: 9-30 VDC or 10-32 VAC 50/60 Hz

For DC power, either polarity is acceptable.

To maintain full isolation and avoid malfunctions, do not connect power supplies in common with input, output or unit power.

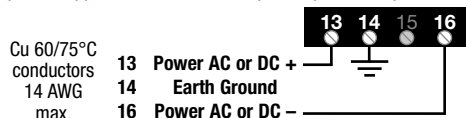

Cu 60/75°C
conductors
14 AWG
max.



To avoid damage to the module, do not make any connections to unused terminals

Wire terminal torque
0.5 to 0.6 Nm or
4.4 to 5.3 in-lbs

Mounting to a DIN Rail

Install module vertically on a 35 mm DIN rail in a protective enclosure away from heat sources.

Do not block air flow. Allow 1" (25 mm) above and below housing vents for air circulation.

1. Tilt front of module downward and clip the lower mount with spring clips to the bottom edge of DIN rail.
2. Push front of module upward until upper mount snaps into place.



Removal

Avoid shock hazards! Turn signal input, output, and power off before removing module.

1. Push up on bottom back of module.
2. Tilt the front of module downward to release upper mount from top edge of DIN rail.
3. The module can now be removed from the DIN rail.

APD 8000 Switch Settings

Input Switch Settings

Disconnect power before changing switch settings. Change wiring as needed if input type changes (sinking/sourcing, volts/mA).

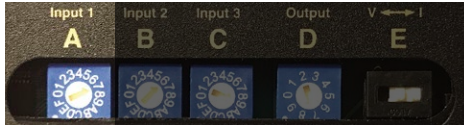

Sensor Type	A
Potentiometer	1
2 Wire RTD	2
3 Wire RTD	3
4 Wire RTD	4
4 Wire RTD with Current Rotation (requires internal jumper change)	5
Thermistor (requires internal jumper change)	6
Thermocouple, single-ended (0 mV or greater)	7
Thermocouple, differential for ungrounded T/Cs or negative mV ranges (typically below 0°C)	8
DC mV or V	9
DC mA (can be wired for sinking or sourcing)	A
Custom range (see module side label)	F

Internal Jumper for Thermistor Input or 4-Wire RTD Input with Current Rotation

To use one of these inputs, an internal jumper must be moved.

1. Remove all power from the module, unplug all connectors, and remove unit from DIN rail.
2. Use a small flat-blade screwdriver to remove the front panel as shown.
3. Note the locations of the seven tabs attaching the side cover.
4. Use the screwdriver to gently pry the tab ends away from the housing. Start with the large tab at the rear, and work towards the front while gently pulling up on the side cover.
5. When all tabs are unlatched, remove the side cover.
6. Pull the jumper out of its holder and place it in the location shown for the required input.
7. Align the side cover and snap into place making sure all seven tabs are engaged. Snap front cover back into place and reinstall unit.

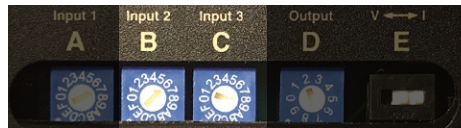
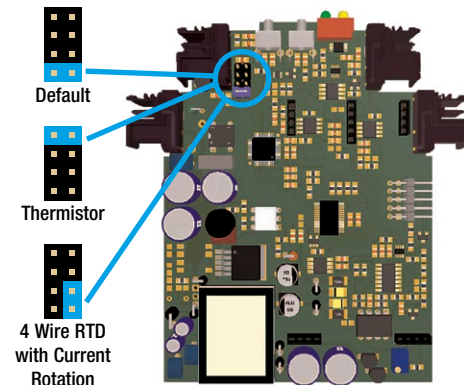

Potentiometer		Excitation Voltage	
Min. Range	Max. Range		B C
1 kΩ	0-1 MΩ	4 V	4 0
500 Ω	0-1 MΩ	2 V	2 0
100 Ω	0-1 MΩ	1 V	1 0

RTD Type	RTD Curve	B C
Cu-10	0.00427	1 8
Cu-100	0.00427	2 8
Ni-100	0.00618	3 8
Ni-120	0.00672	4 8
Ni-Fe-500	0.00518	5 8
Ni-Fe-1000	0.00527	6 8
Ni-Fe-2000	0.00527	7 8
Pt-10	0.00385	8 A
Pt-10	0.003911	8 B
Pt-10	0.003916	8 C
Pt-10	0.003926	8 D
Pt-25	0.003926	9 D
Pt-50	0.00385	A A
Pt-50	0.003911	A B
Pt-50	0.003916	A C
Pt-50	0.003926	A D
Pt-100	0.00385	B A
Pt-100	0.003911	B B
Pt-100	0.003916	B C
Pt-100	0.003926	B D
Pt-200	0.00385	C A
Pt-200	0.003911	C B
Pt-200	0.003916	C C
Pt-200	0.003926	C D
Pt-470	0.003926	D D
Pt-500	0.00385	E A
Pt-500	0.003911	E B
Pt-500	0.003916	E C
Pt-500	0.003926	E D
Pt-1000	0.00375	F 9
Pt-1000	0.00385	F A
Pt-1000	0.003911	F B
Pt-1000	0.003916	F C
Pt-1000	0.003926	F D

Thermistor	Ohms @ 25°C	B C
44004/44033	2.252 kΩ	1 8
44005/44030	3 kΩ	2 8
44007/44034	5 kΩ	3 8
44006/44031	10 kΩ	4 8
44008/44032	30 kΩ	5 8
YSI 400	2.252 kΩ	6 8
Spectrum 1003	1 kΩ	7 8

T/C Type	B	T/C Burnout	C
B	1	Upscale (default)	9
C	2	Downscale	A
D	3	None, last known value	B
E	4		
G	5		
J	6		
K	7		
M	8		
N	9		
P	A		
R	B		
S	C		
T	D		

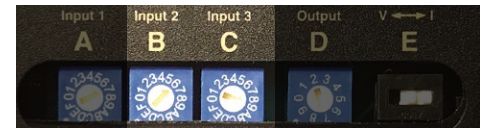

DC Voltage	B C	DC Current	B C
±25 mV	B 3	±0.5 mA	B B
±100 mV	1 4	±1 mA	D B
±50 mV	D 3	±2 mA	1 C
±125 mV	3 4	±2.5 mA	3 C
±200 mV	5 4	±4 mA	5 C
±250 mV	8 4	±5 mA	8 C
±500 mV	D 4	±8 mA	A C
±800 mV	1 5	±10 mA	D C
±1 V	1 6	±16 mA	1 D
±1.25 V	3 6	±20 mA	2 D
±2 V	5 6	0-1 mA	C B
±2.5 V	8 6	0-2 mA	E B
±4 V	A 6	0-4 mA	2 C
±5 V	D 6	0-5 mA	4 C
±8 V	1 7	0-8 mA	6 C
±10 V	2 7	0-10 mA	9 C
0-50 mV	C 3	2-10 mA	7 C
0-100 mV	E 3	0-16 mA	B C
100-500 mV	7 4	0-20 mA	E C
200-1000 mV	C 4	4-20 mA	C C
0-200 mV	2 4		
0-250 mV	4 4		
0-400 mV	6 4		
0-500 mV	9 4		
0-800 mV	B 4		
0-1 V	E 4		
0-2 V	2 6		
0-2.5 V	4 6		
0-4 V	6 6		
0-5 V	9 6		
1-5 V	7 6		
0-8 V	B 6		
0-10 V	E 6		
2-10 V	C 6		

Note: For a mA input, your device must provide power to the input loop.

Custom Input	B C
See module side label for type and range	F 8

Output Switch Settings

Disconnect power before changing switch settings. Change wiring as needed if output type changes (sinking/sourcing, volts/mA).

For models with the "R" option indicated on the white side label, output ranges are reversed. This is factory set and can not be changed in the field.

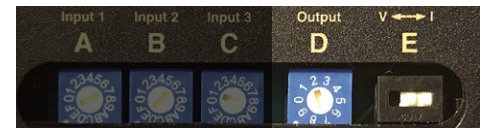

Voltage Output	D E	Current Output	D E
0-1 V	0 V	0-2 mA	0 I
0-2 V	8 V	0-4 mA	8 I
0-4 V	1 V	0-8 mA	1 I
0-5 V	9 V	0-10 mA	9 I
1-5 V	6 V	0-10 mA	6 I
0-8 V	2 V	0-16 mA	2 I
0-10 V	3 V	0-20 mA	3 I
2-10 V	7 V	4-20 mA	7 I
±5 V	4 V		
±10 V	5 V		

mA output can be wired for sinking or sourcing.



Range Calibration

Input and output ranges, if specified on your order, are factory pre-configured (at 24°C ±1°C).

Note: Perform the following calibration procedure any time switch settings are changed.

1. Connect a multimeter to the output terminals 2 and 3, or 3 and 4 depending on output type. See wiring diagram.
2. Connect an appropriate VDC, mADC, potentiometer or temperature simulator to the input of the module.
3. Connect power to the unit (terminals 13, 14, and 16) and apply power to the module.
4. Wait until the yellow Status LED blinks (once per second).

Low End Input Calibration

5. Use the simulator to apply the low end of the input signal.
6. Push the **Set** button to store the low end input value.
7. The Status LED will turn on to indicate the reading was saved.
8. Use the **Up** and **Down** buttons to adjust the output to the desired low output reading. For example: 4 mA for a 4-20 mA output or -10 V for a ±10 V output.
9. Press and release the **Set** button to store the low output.

High End Input Calibration

10. Wait until the yellow Status LED blinks (once per second).
11. Use the simulator to apply the high end of the input signal.
12. Push the **Set** button to store the high end input value.
13. The Status LED will turn on to indicate the reading was saved.
14. Use the **Up** and **Down** buttons to adjust the output to the desired high output reading (i.e. 20 mA for a 4-20 mA output).
15. Press and release the **Set** button to store the high output.

Output Test Level Adjustment

16. Wait until the Status LED turns on and stays on.
17. Use the **Up** and **Down** buttons to adjust the test output to the desired level (i.e. 12 mA for a 4-20 mA output).
18. Press and release the **Set** button to store the test output.
19. Wait until the Status LED starts blinks once per second.
20. To change any value, turn off the power and repeat steps 1 to 19.

Saving Setup

21. Press and release the **Set** button to store the settings in memory. The Status LED will turn on during the storing process.
22. Once the Status LED turns off, setup and configuration is complete. Turn off power to the unit and remove the simulator and multimeter.

Blinking Yellow LED Setup Error Codes

If an error occurred or invalid selection was made, the yellow Status LED blinks an error code. Check switches A, B, C, and input wiring.

- | | |
|---------------------------------------|------------|
| 2 1 Invalid sensor selected | ●●—● |
| 2 2 Invalid pot. excitation selected | ●●—●● |
| 2 3 Invalid RTD selected | ●●—●●● |
| 2 4 Invalid thermistor selected | ●●—●●●● |
| 2 5 Invalid T/C selected | ●●—●●●●● |
| 2 6 Invalid direct DC selected | ●●—●●●●●● |
| 2 7 Invalid input setting (Zero>Span) | ●●—●●●●●●● |

Adjusting the Output After Installation

It may be necessary to fine-tune the output signal after installation to account for offset, tare, lead length, or operating temperature.

1. Press and release the **Set** button. This will turn on the yellow Status LED.
2. Use the **Up** and **Down** buttons to adjust the output to the desired level. The Status LED will turn off during the adjustment.
3. Once the desired output level has been met, press and release the **Set** button to save the adjustment. The Status LED will flash indicating that the change has been made.

The unit has an auto Zero/Span detection for knowing which to adjust. If the output signal is greater than 50% of the Span, the unit will adjust the output signal Span.

If the output signal is less than 50% of the Span, the unit will adjust the output signal Zero.

Resetting I/O Ranges

To reset the unit back to factory default without changing any input switch settings press and hold the **Set** button while the module is being powered up.

If you change the input switch setting, the unit will automatically start in setup mode to allow you to calibrate and store your new configuration.

Output Test Function

When the **Test** button is pressed it will drive the output with a known good signal that can be used as a diagnostic aid during initial start-up or troubleshooting. When pressed again, the output will return to normal. The button allows hands-free operation of the Test Mode.

The Test level can be adjusted by using the **Up** and **Down** buttons.

The level can be saved by pressing the **Set** button, or it can default back to the setup value by not pressing the **Set** button.

Operation

The APD 8000 accepts a DC, potentiometer, or temperature input and provides a linearized and optically isolated DC voltage or current output.

The green LoopTracker® input LED provides a visual indication that a signal is being sensed by the input circuitry of the module. It also indicates the input signal strength by changing in intensity as the process changes from minimum to maximum.

If the LED fails to illuminate, or fails to change in intensity as the process changes, check the module power or signal input wiring.

The yellow status LED provides a visual indication of operational modes.

Normal operation: Off

Push-to-Test mode: Steadily on

User setup mode: Blinking once per second

Note that it may be difficult to see the LEDs under bright lighting conditions.

Blinking Yellow LED Operational Error Codes

If an error occurs during operation, the yellow Status LED blinks an error code. Check sensor, wiring, or consult factory.

- | | |
|--|-----------|
| 1 1 Analog to digital converter out-of-range | ●—● |
| 1 2 Sensor under range | ●—●● |
| 1 3 Sensor over range | ●—●●● |
| 1 4 Cold Junction Compensation sensor abnormal range | ●—●●●● |
| 1 5 Cold Junction Compensation sensor failure | ●—●●●●● |
| 1 6 Hard Analog to digital converter out-of-range | ●—●●●●●● |
| 1 7 Sensor hard fault: Open circuit, hard Analog to digital converter fault, or hard CJC fault | ●—●●●●●●● |